

Tomatina

TRENCH

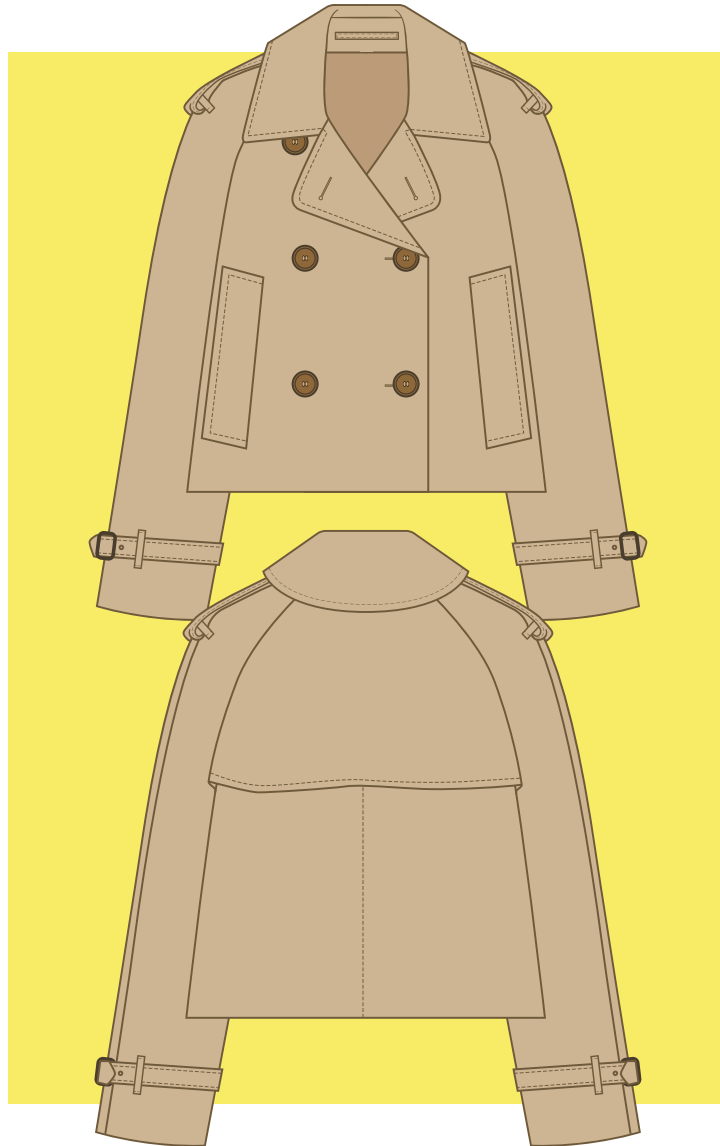

Copycat

MOLDES PARA IMPRIMIR EN A4
TALLES 2XS AL 3XL

Trench Tomasina

Copycat

**MUESTRA DE ESCALA
10 x 10 cm**

CHEQUEAR ESCALA

IMPORTANTE:

Para ahorrar cantidad de papel en la impresión, algunos patrones fueron superpuestos entre sí.

De igual modo y para mejor lectura, los patrones correspondientes a las piezas de forrería están dibujados en **rojo oscuro**.

1. Referencia de piezas

- 2.
3. DELANTERO
4. ESPALDA
5. MANGA TRASERA
6. MANGA DELANTEA
7. CUELLO EXTERIOR
8. CUELLO INTERIOR
9. TIRILLA DE CUELLO
10. VISTA DELANTERA
11. FORRO DELANTERO
12. FORRO MANGA TRASERA
13. FORRO MANGA DELANTERA
14. VISTA DE MANGAS
15. VISTA DE ESPALDA
16. FORRO DE ESPALDA
17. RIBETE BOLSILLO/VISTA BOLSILLO
18. CAPA DE ESPADA
19. VISTA DE FONDO DE BOLSILLO
20. FONDO DE BOLSILLO
21. CHARRETERA
22. CINTURÓN DE PUÑO
23. PRESILLAS/PASACINTOS

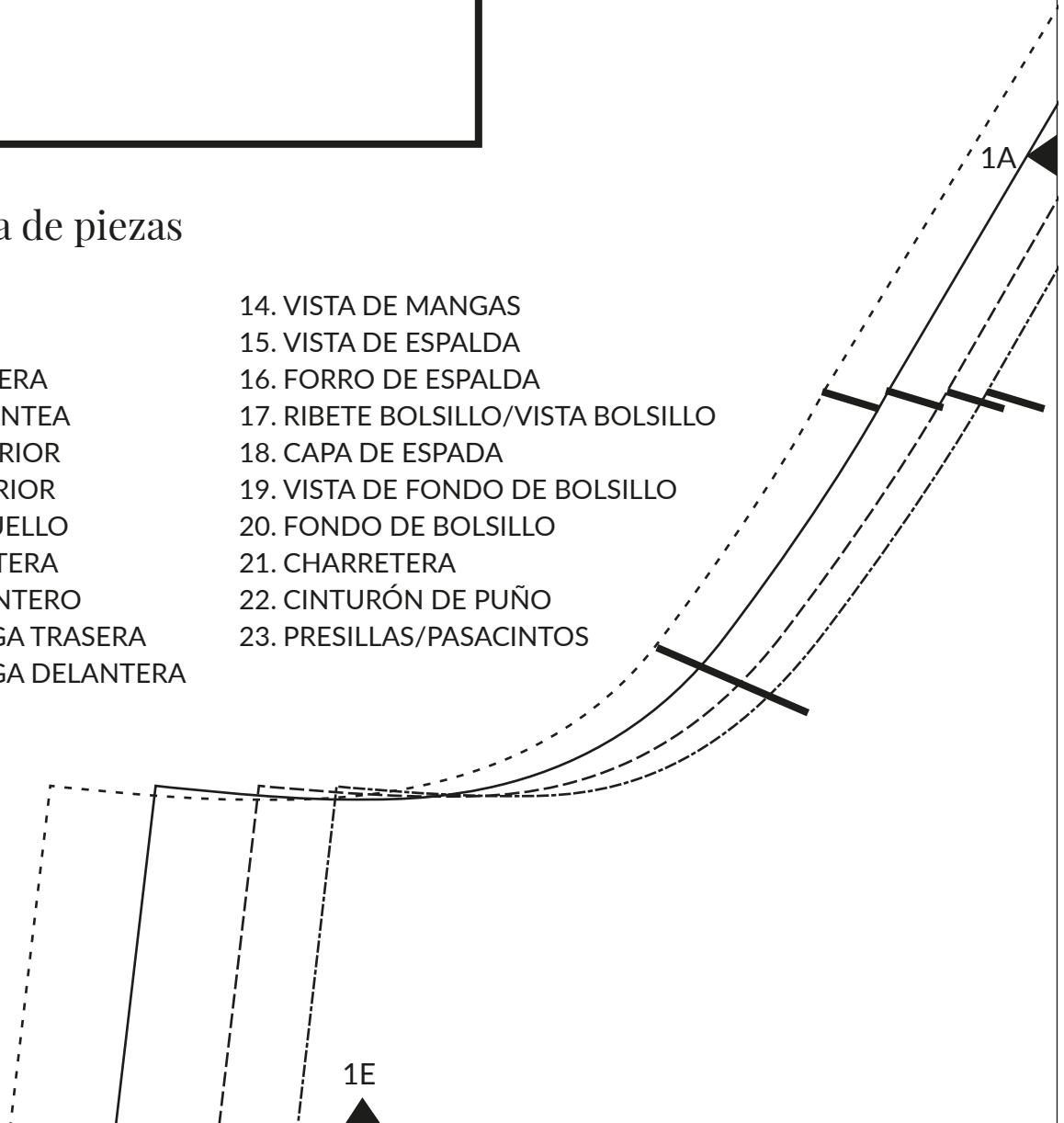

2

Copycat

TRENCH TOMASINA

ESPALDA

Talles:

- - - - - 2XL/3XL
- L/XL
- - - - - S/M
- · - · - XS/2XS



CORTAR:
1 EN TELA DOBLE EXTERIOR

No incluye márgenes de costura

1A

1B

1F

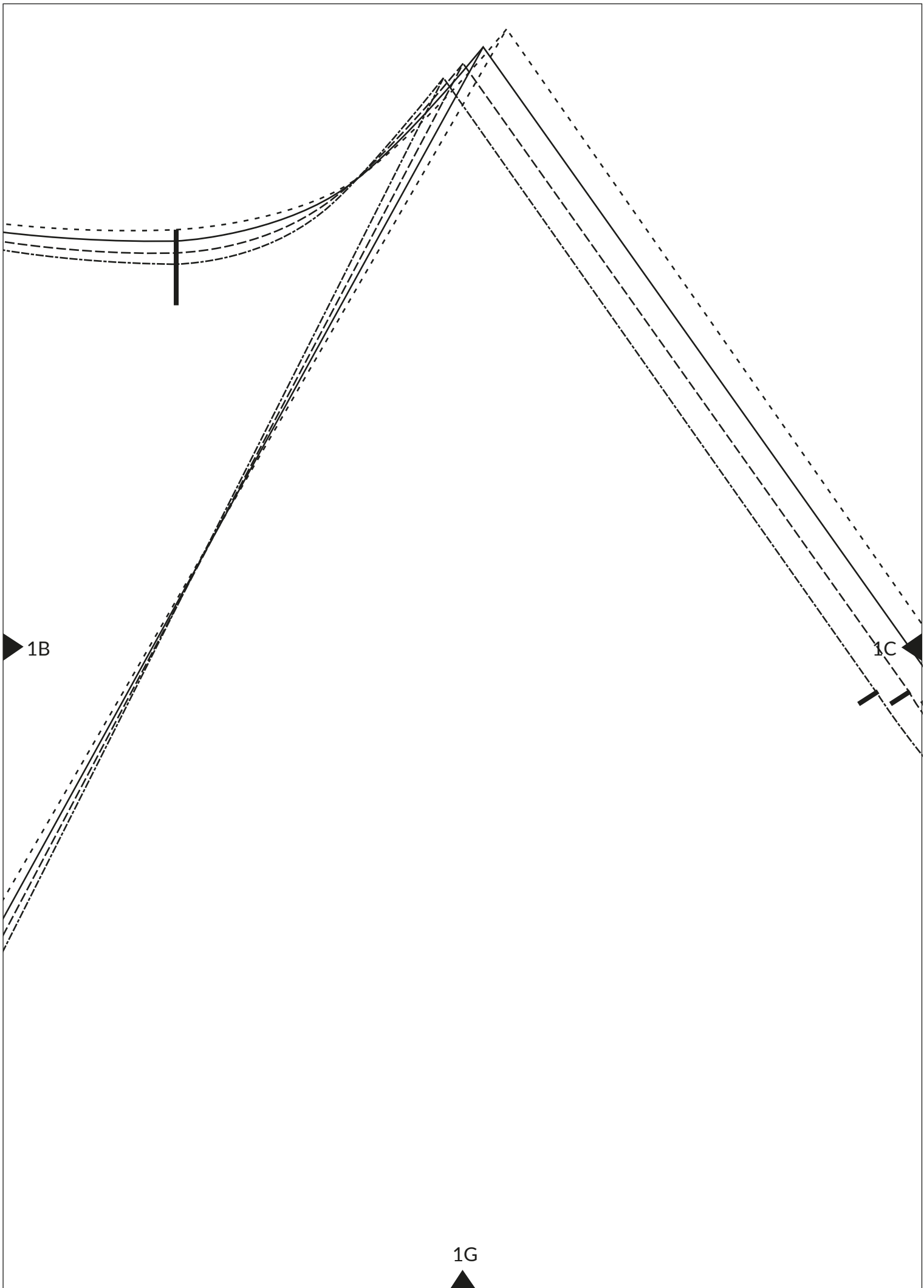



12

Copycat
TRENCH TOMASINA
VISTA DE MANGAS

CORTAR: 1 EN TELA
SIMPLE EXTERIOR

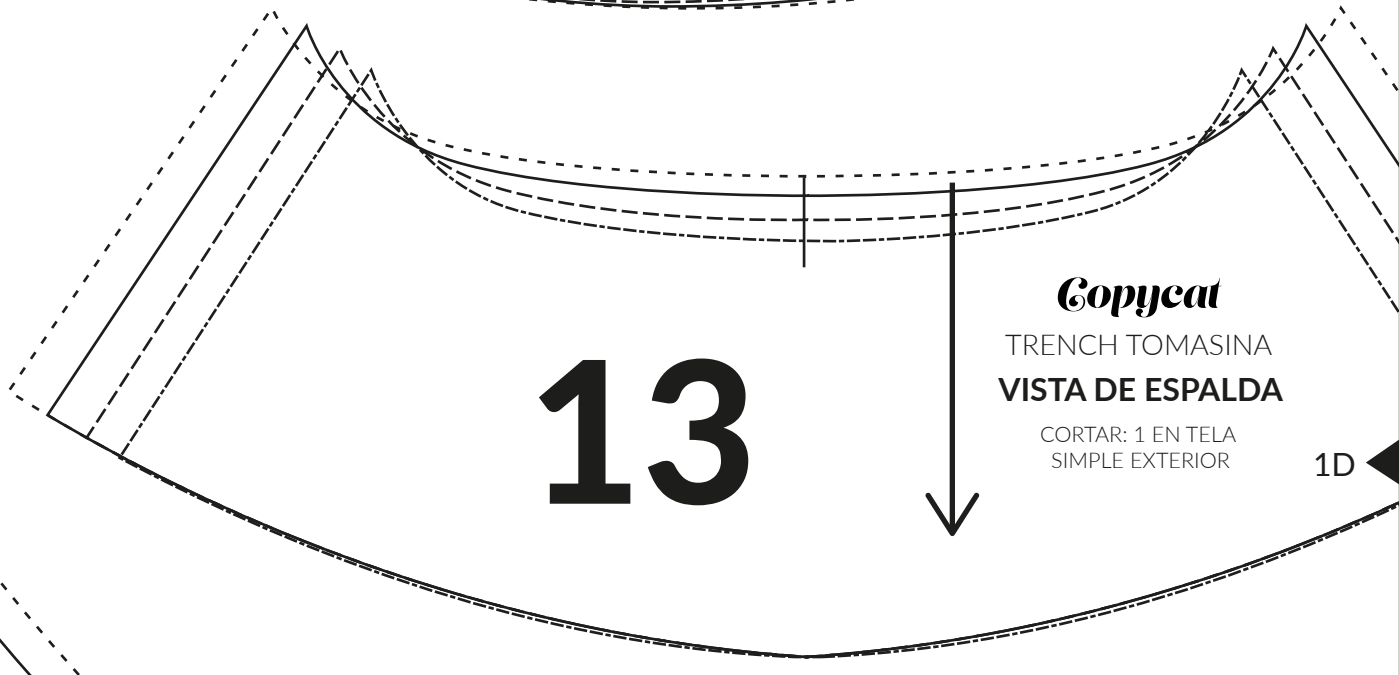

13

Copycat
TRENCH TOMASINA
VISTA DE ESPALDA

CORTAR: 1 EN TELA
SIMPLE EXTERIOR

1C

1D

1H



1D

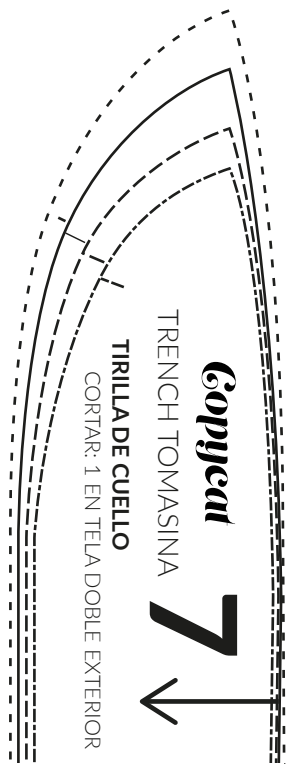

Copycat

TRENCH TOMASINA

TIRILLA DE CUELLO

CORTAR: 1 EN TELA DOBLE EXTERIOR



15

Copycat

TRENCH TOMASINA
RIBETE DE BOLSILLO

CORTAR: 2 EN TELA
DOBLE EXTERIOR



Copycat

TRENCH TOMASINA

CUELLO INTERIOR

6



CORTAR:
1 EN TELA DOBLE EXTERIOR

No incluye márgenes de costura

1i

1E

2A

17

Copycat

TRENCH TOMASINA

VISTA DE FONDO BOLSILLO

CORTAR: 1 EN TELA
DOBLE INTERIOR

2E

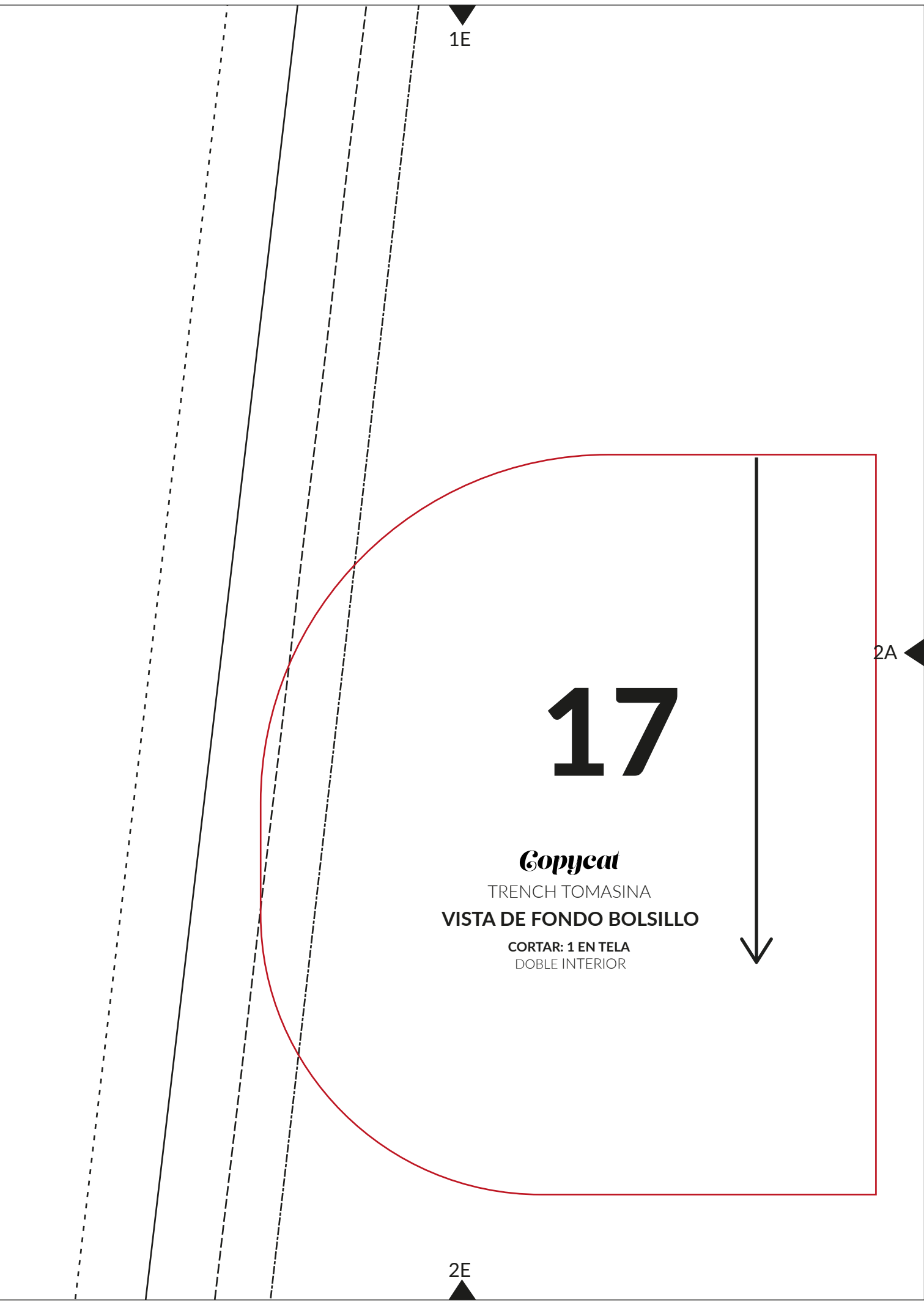

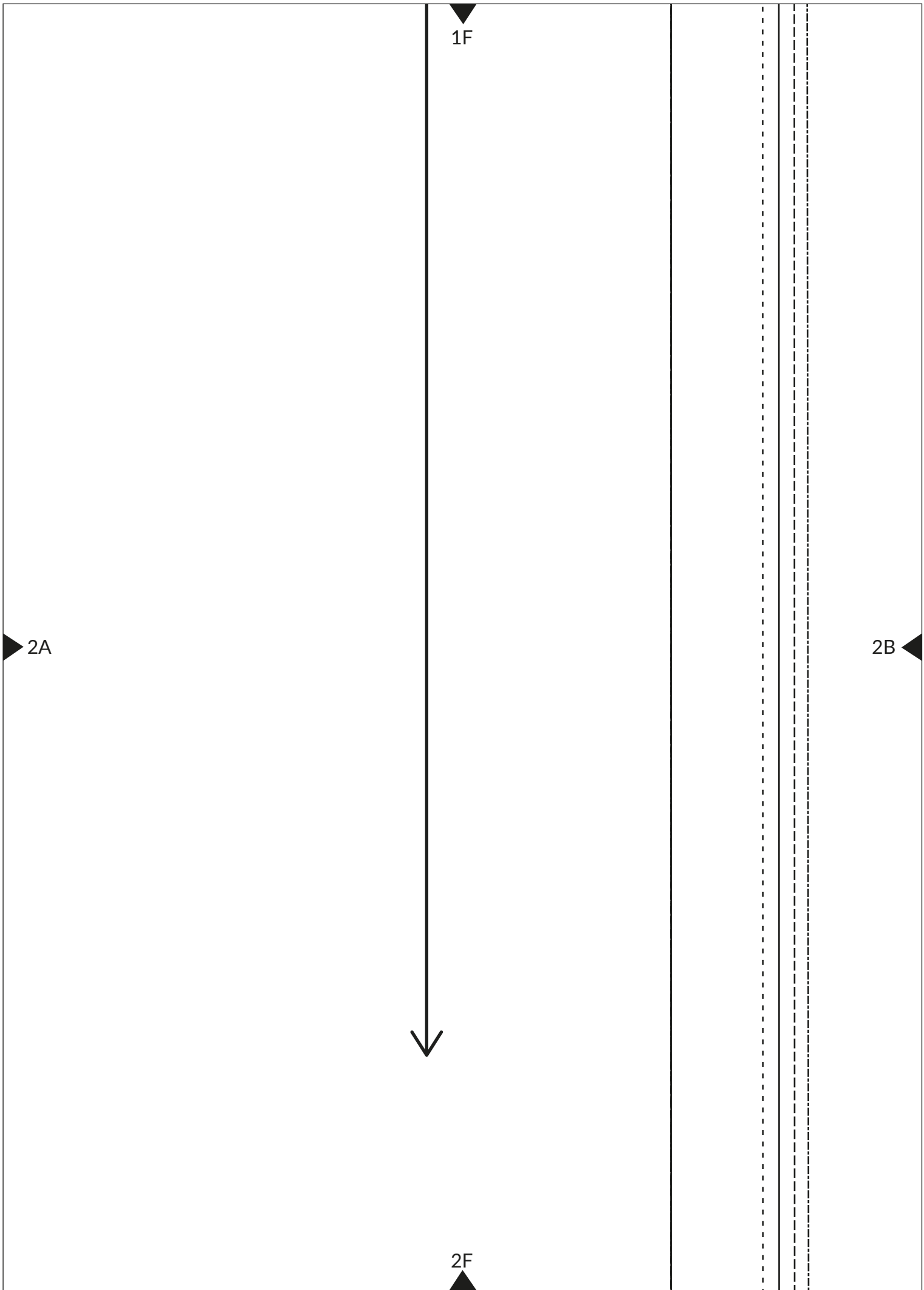

1G

2B

1

2C

Copycat

TRENCH TOMASINA

DELANTERO

Talles:

----- **2XL/3XL**

————— **L/XL**

----- **S/M**

----- **XS/2XS**



CORTAR:
1 EN TELA DOBLE EXTERIOR

No incluye márgenes de costura

2G

TRANSFERIR LAS TI

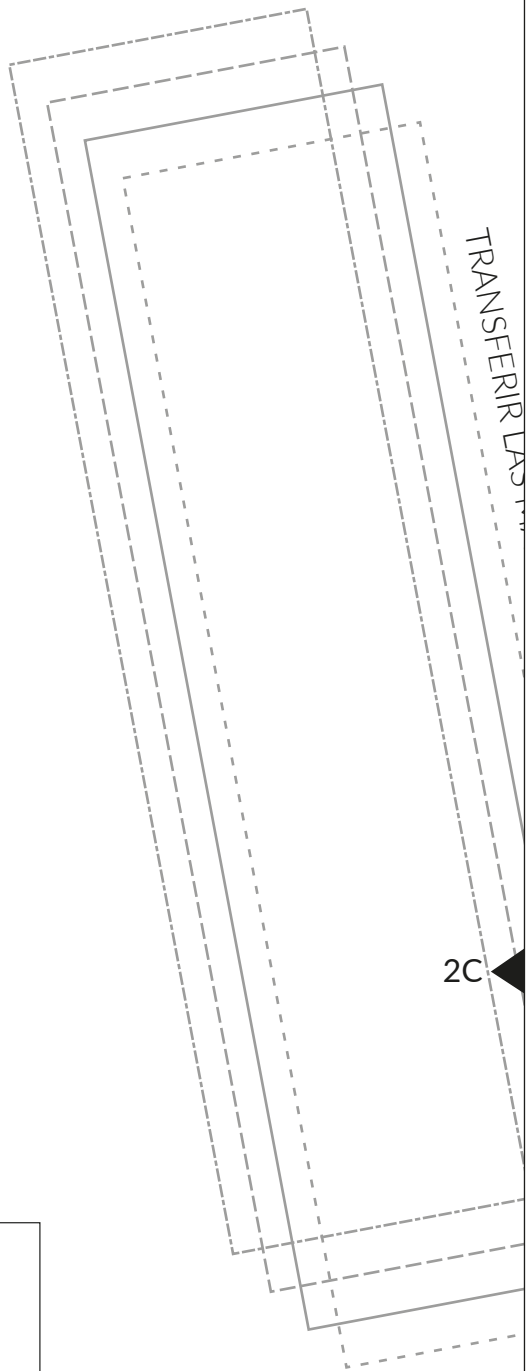

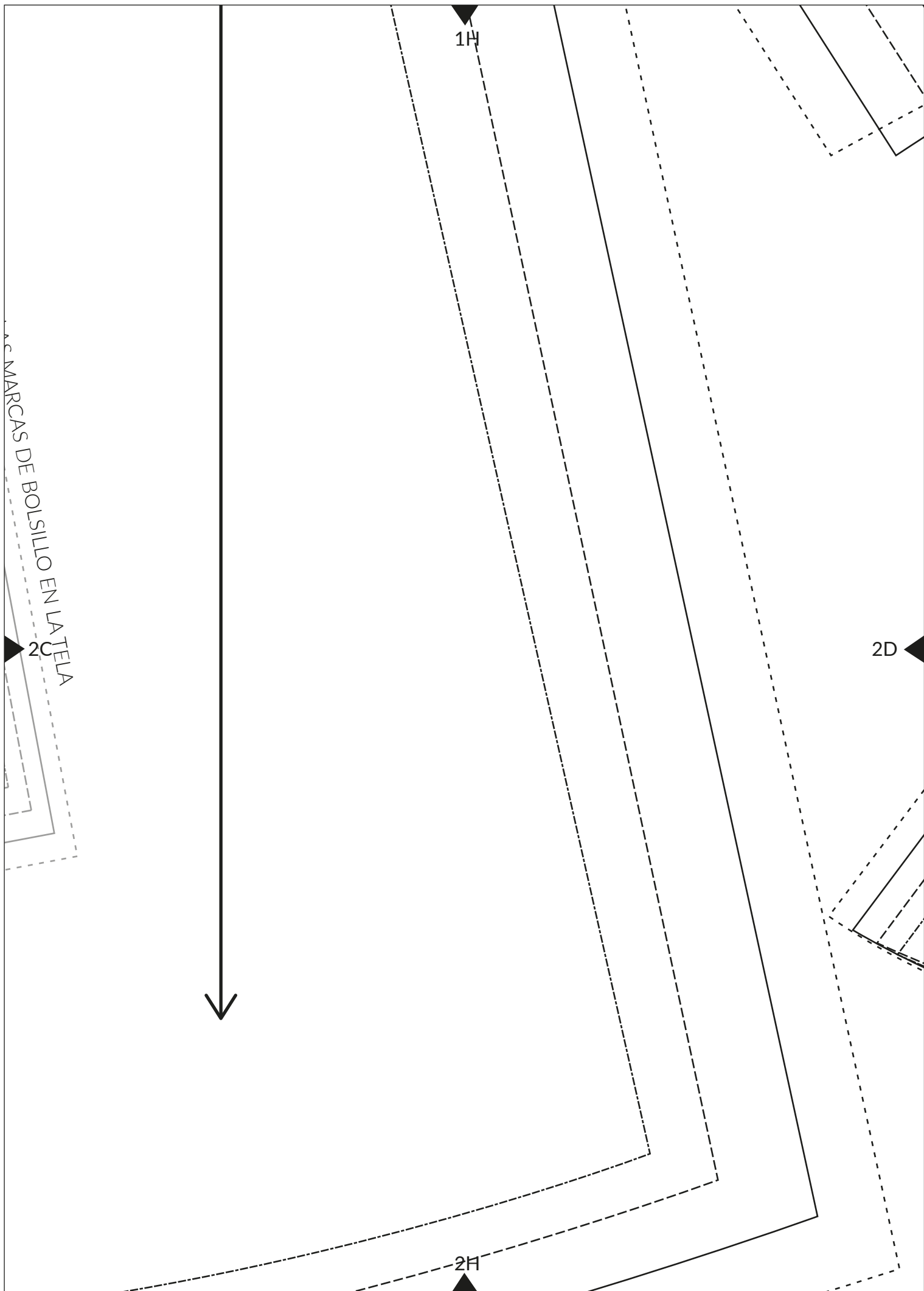

1H

2D

2H

2C

MARCAS DE BOLSILLO EN LA TELA



1i

16

2D

Copycat

TRENCH TOMASINA

CAPA DE ESPALDA

Talles:

----- 2XL/3XL

————— L/XL

----- S/M

----- XS/2XS



CORTAR:

1 EN TELA DOBLE EXTERIOR

1 EN TELA DOBLE INTERIOR

No incluye márgenes de costura

2i

Gopycat

TRENCH TOMASINA

PRESILLAS

No incluye márgenes de costura



19

Gopycat

TRENCH TOMASINA

CHARRETERAS



20

Gopycat

TRENCH TOMASINA

CINTURÓN DE PUÑOS

3E

2E

3A

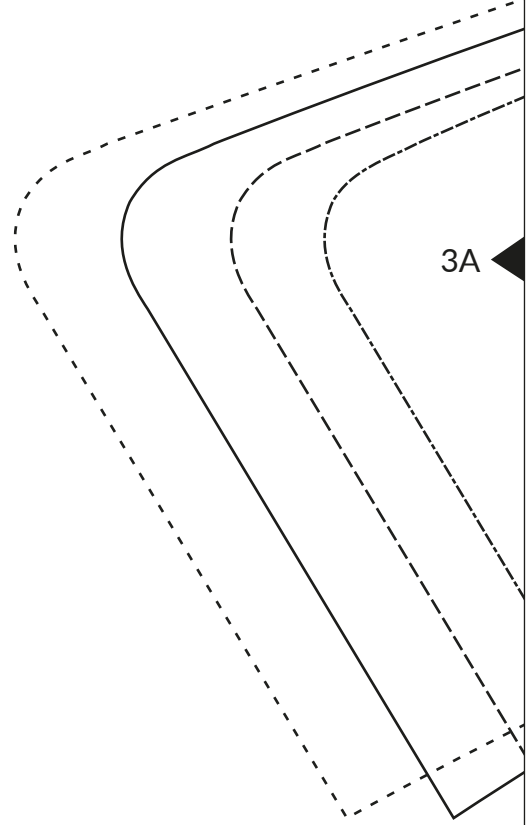

2F

Copycat

TRENCH TOMASINA

CUELLO EXTERIOR

5



CORTAR:
1 EN TELA DOBLE EXTERIOR

No incluye márgenes de costura

DOBLEZ DE LA TELA

3A

3B

3F

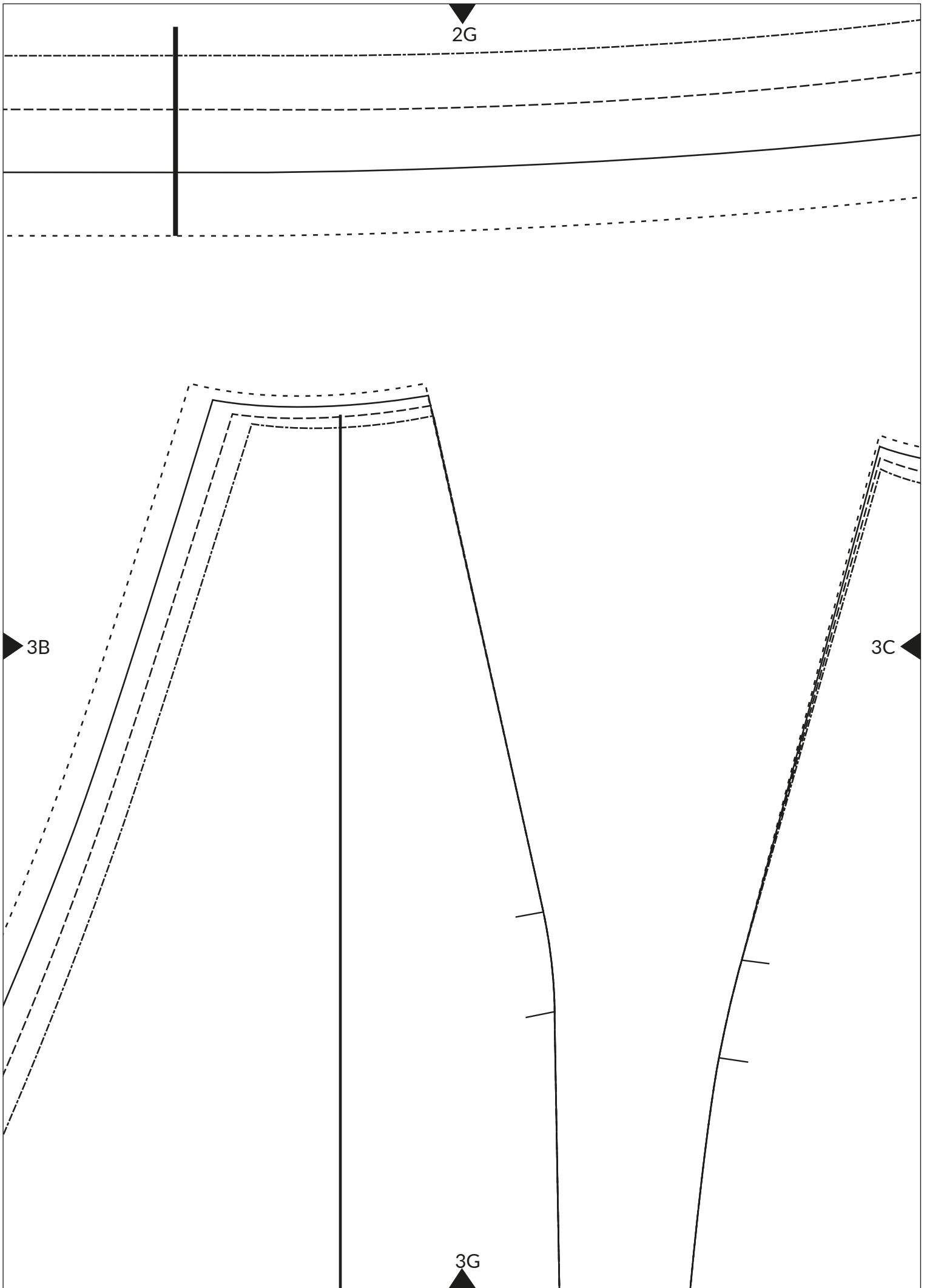

2H

18

Copycat

TRENCH TOMASINA
FONDO BOLSILLO

CORTAR: 1 EN TELA
DOBLE INTERIOR

3C

3D

3H

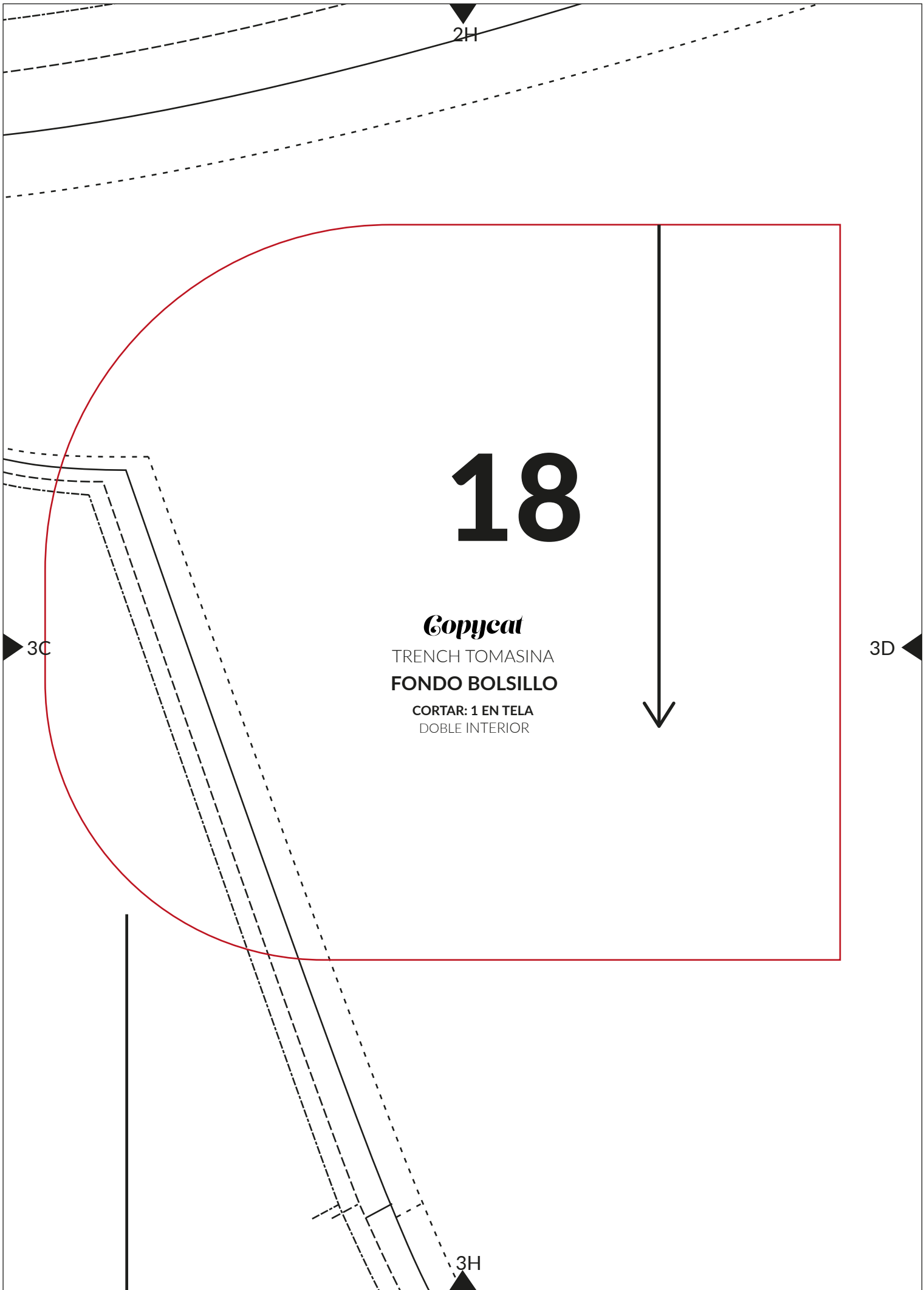

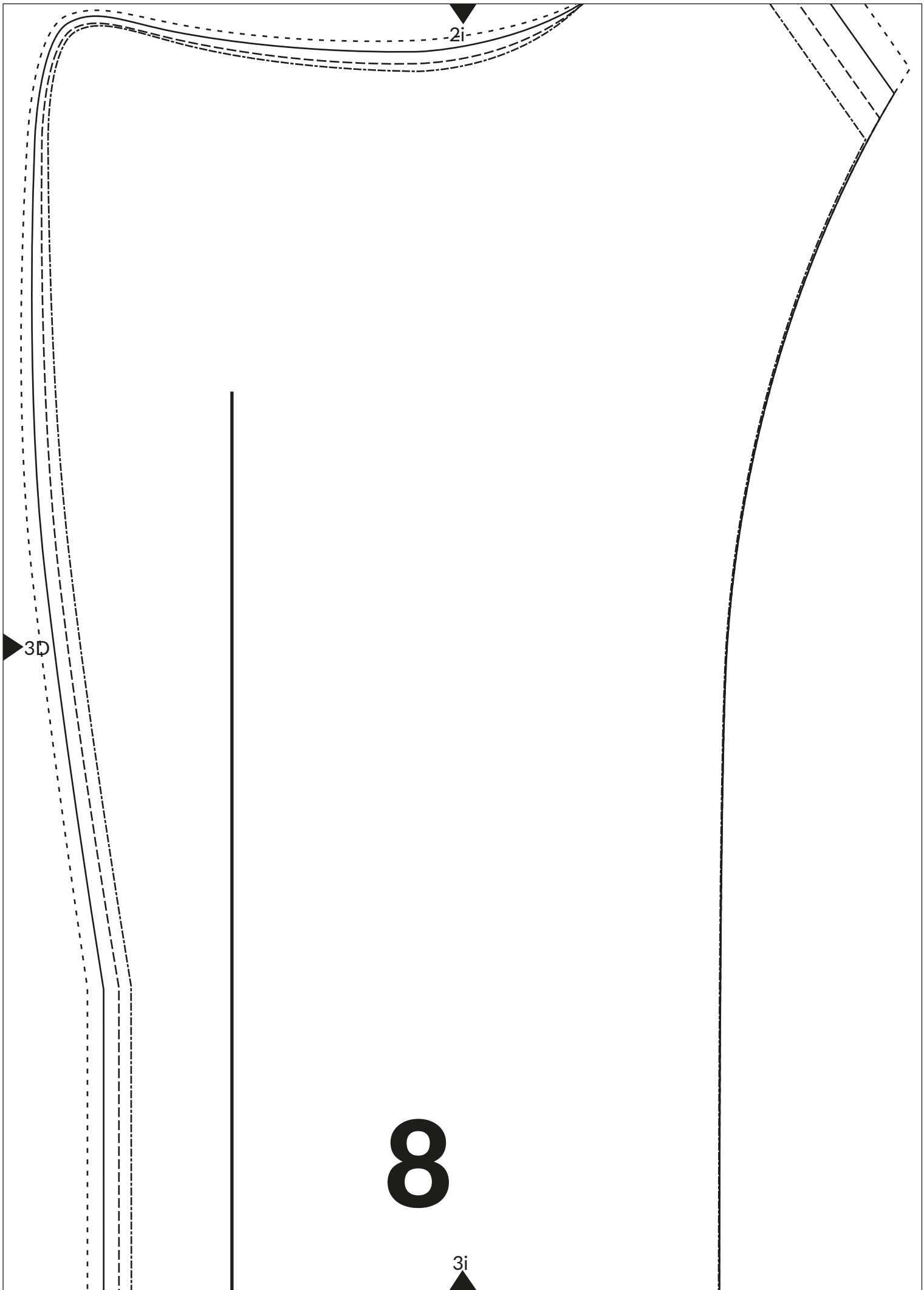

21

 CORTAR:
2 EN TELA DOBLE EXTERIOR



CORTAR:
2 EN TELA DOBLE EXTERIOR
No incluye márgenes de costura

3E



CORTAR:
2 EN TELA DOBLE EXTERIOR
No incluye márgenes de costura

4A

4E

9

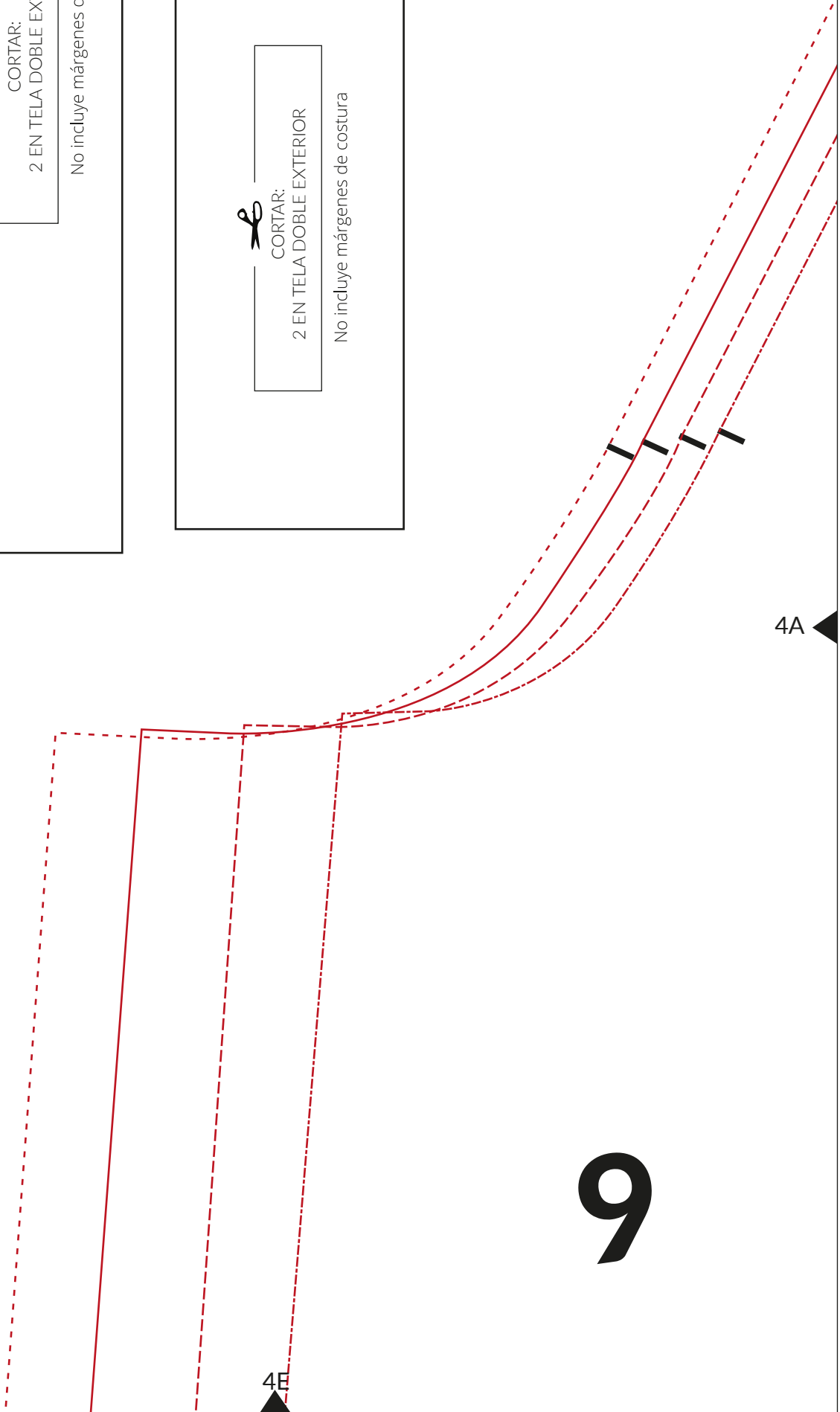

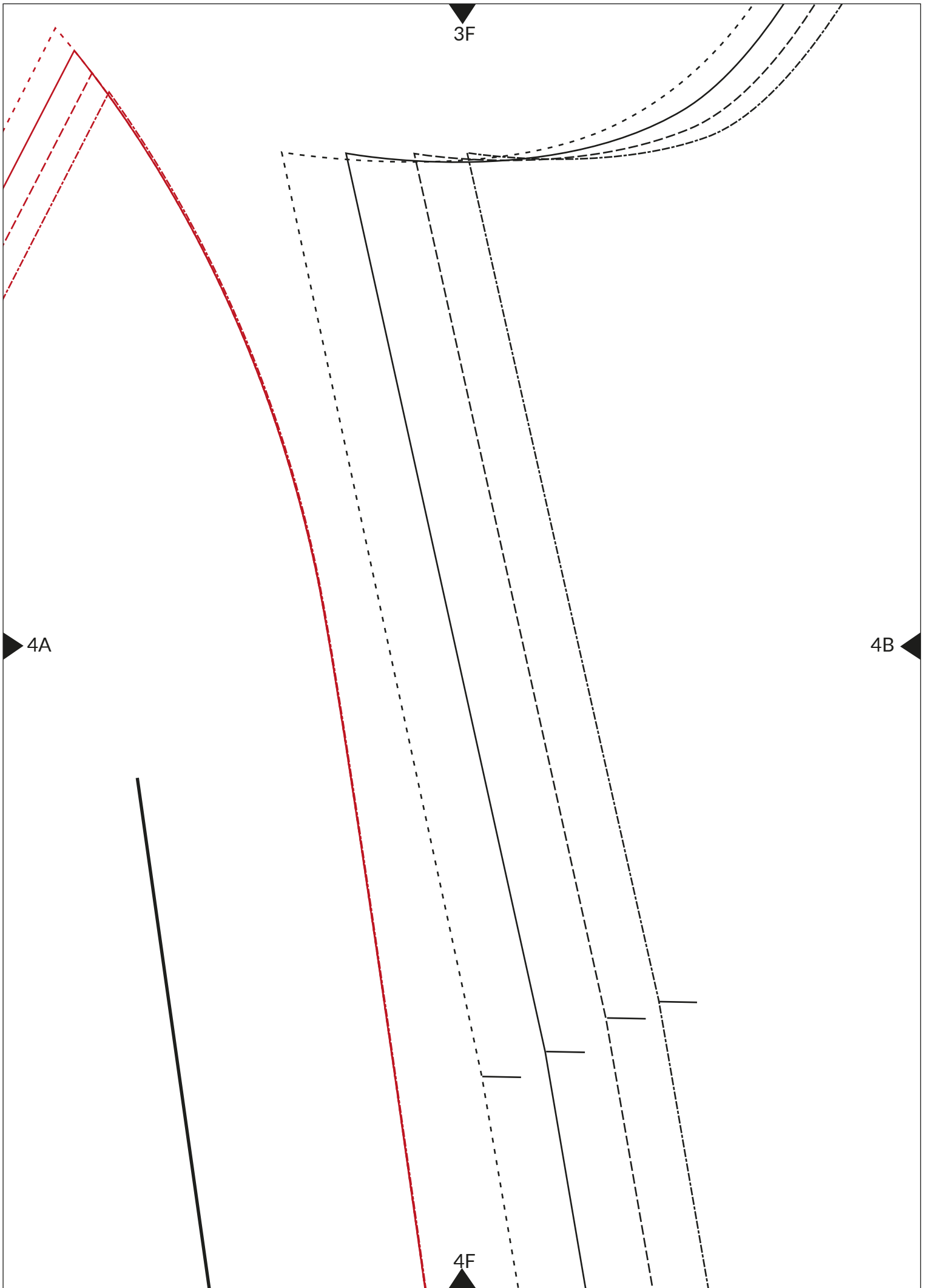

3G



3

Copycat

TRENCH TOMASINA

MANGA DE ESPALDA

Talles:

----- 2XL/3XL

————— L/XL

----- S/M

----- XS/2XS



CORTAR:
1 EN TELA DOBLE EXTERIOR

No incluye márgenes de costura

4B

4C

4G

4

Copycat

TRENCH TOMASINA

MANGA DELANTERA

Talles:

- - - - - 2XL/3XL
- L/XL
- - - - - S/M
- - - - - XS/2XS



CORTAR:
1 EN TELA DOBLE EXTERIOR

No incluye márgenes de costura

3H

4C

4D

4H

3i

Copycat

TRENCH TOMASINA

VISTA DELANTERA

Talles:

----- 2XL/3XL

_____ L/XL

----- S/M

----- XS/2XS



CORTAR:
1 EN TELA DOBLE EXTERIOR

No incluye márgenes de costura

4D

4i

4E

Gopycat
TRENCH TOMASINA
INTERIOR DELANTERO

Talles:

- 2XL/3XL
- _____ L/XL
- S/M
- XS/2XS



CORTAR:
1 EN TELA DOBLE INTERIOR

No incluye márgenes de costura

5A

5E

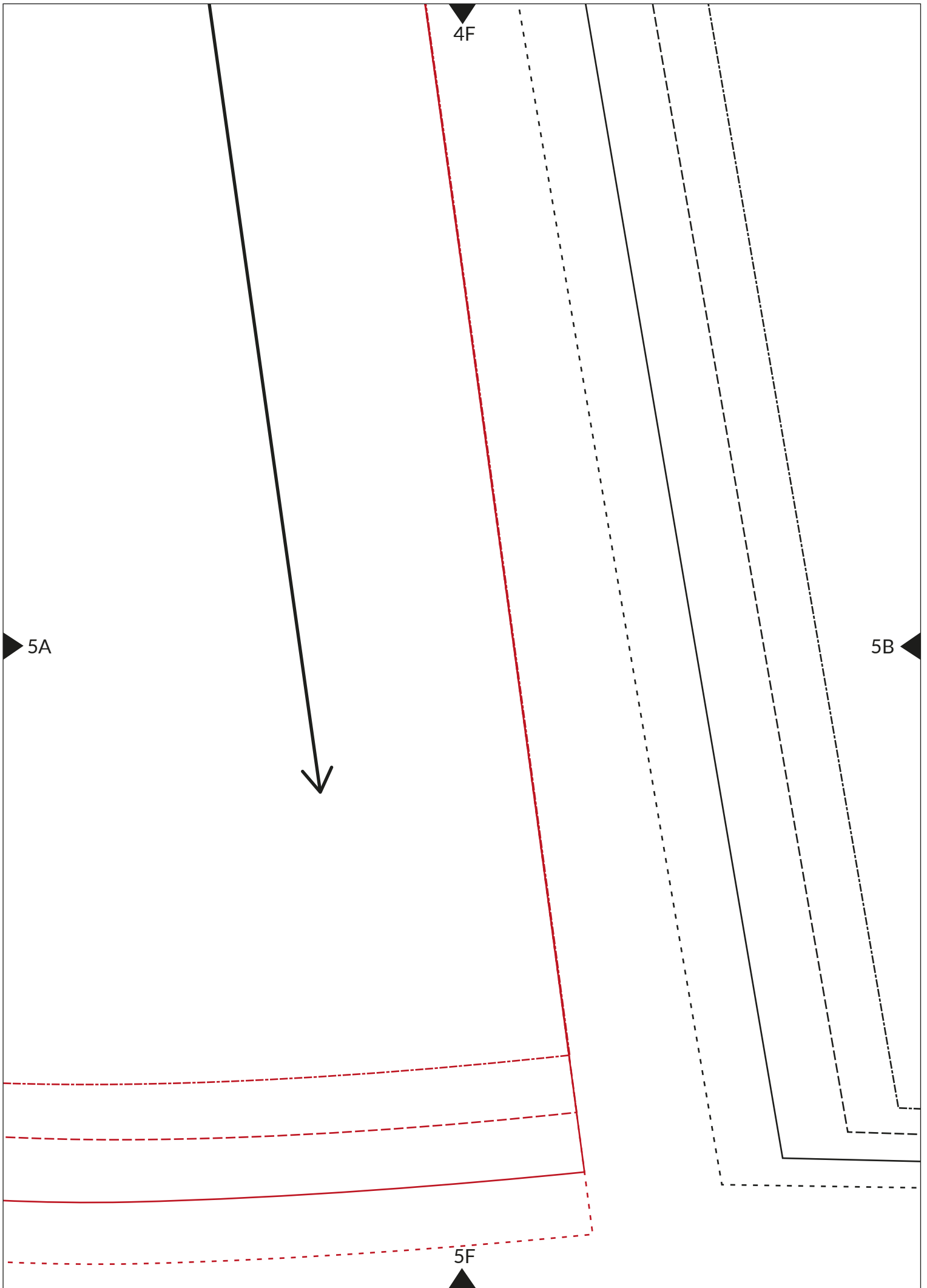

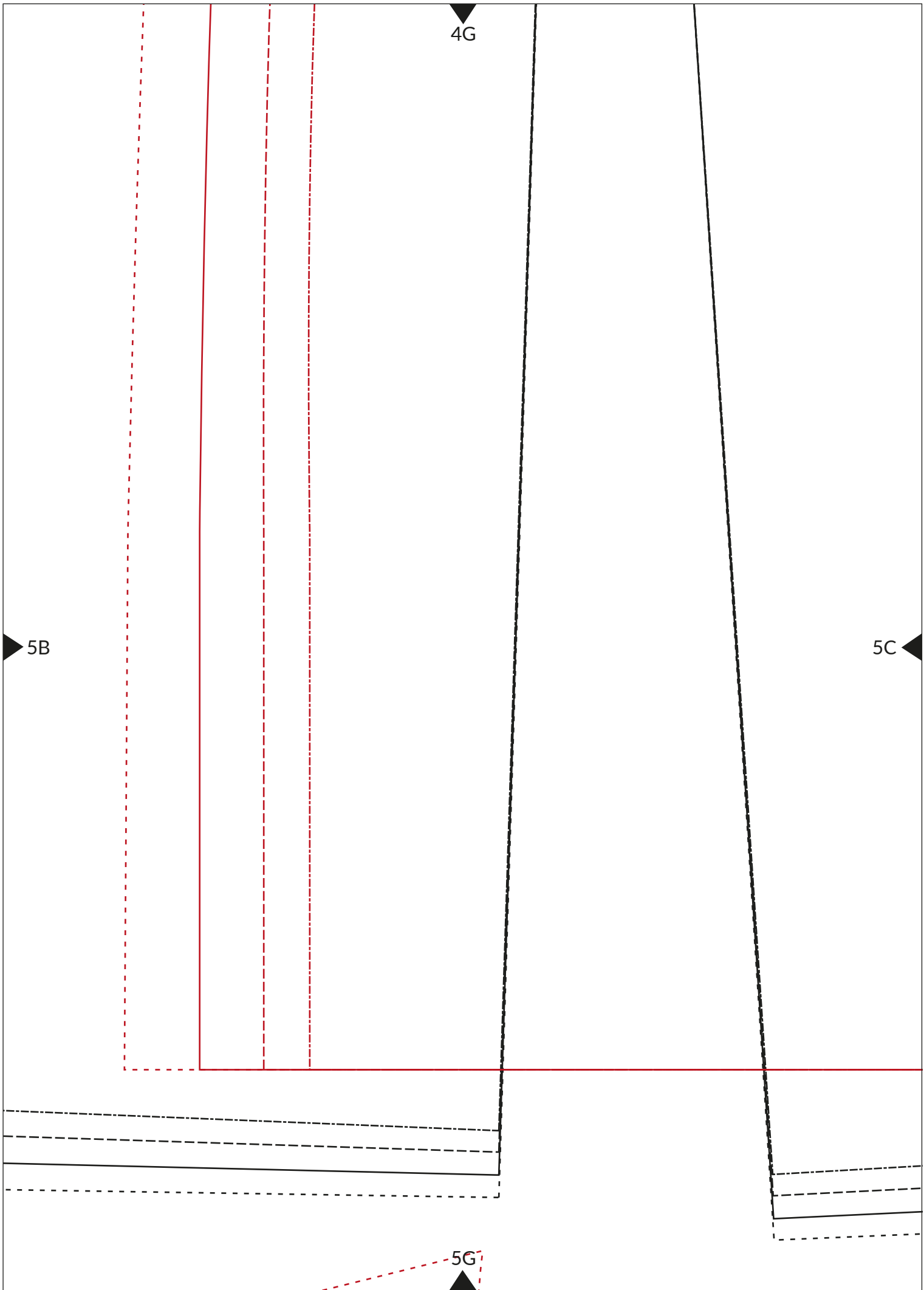

4G

5B

5C

5G

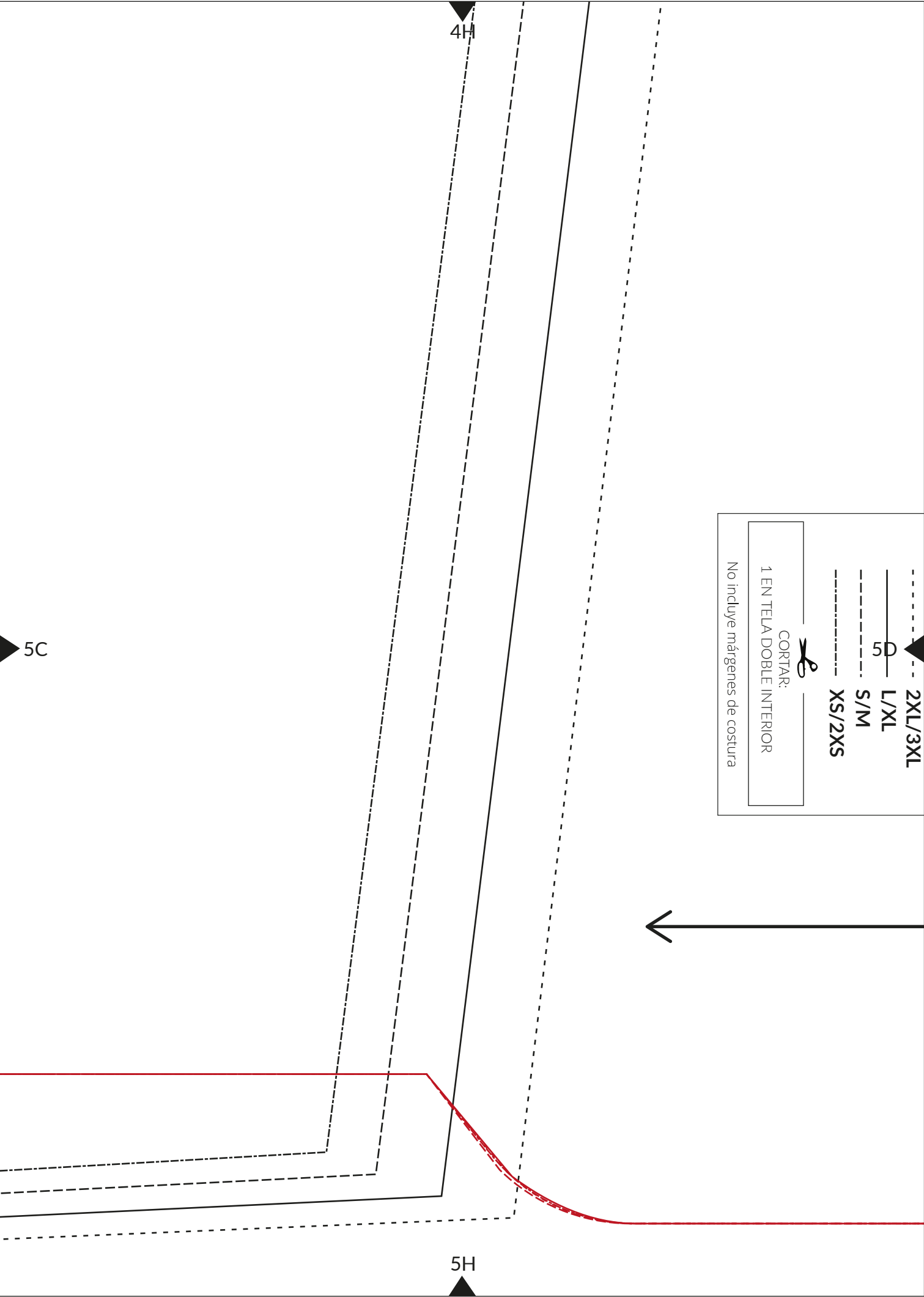

4i

5i

14

Gopyscat

TRENCH TOMASINA

INTERIOR ESPALDA

Talles:

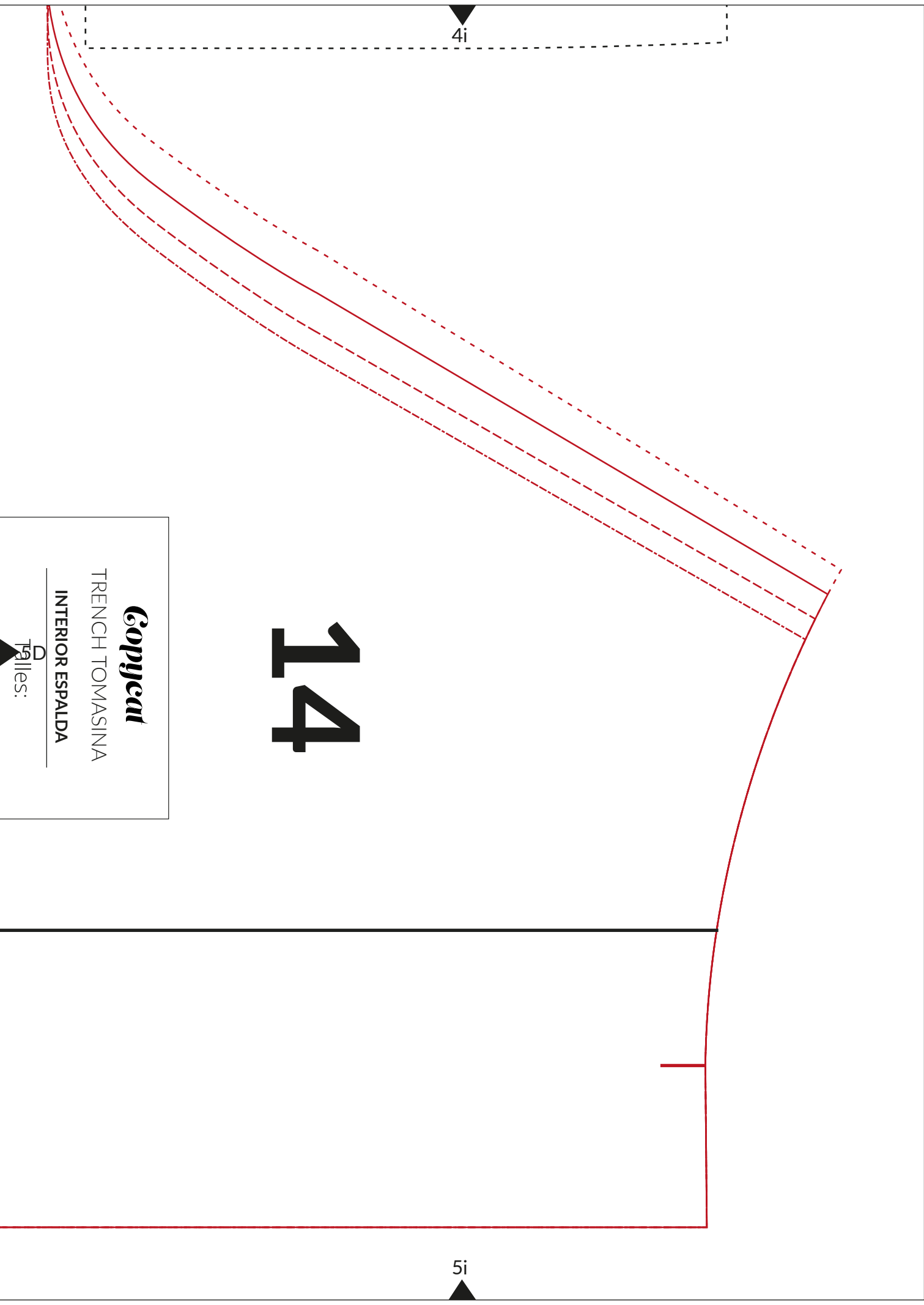

5E

6A

2XL/3XL

L/XL

S/M

XS/2XS



CORTAR:

1 EN TELA DOBLE INTERIOR

No incluye márgenes de costura



5F

6B

10

6A

Gopycat

TRENCH TOMASINA

INTERIOR MANGA ESPALDA

Talles:

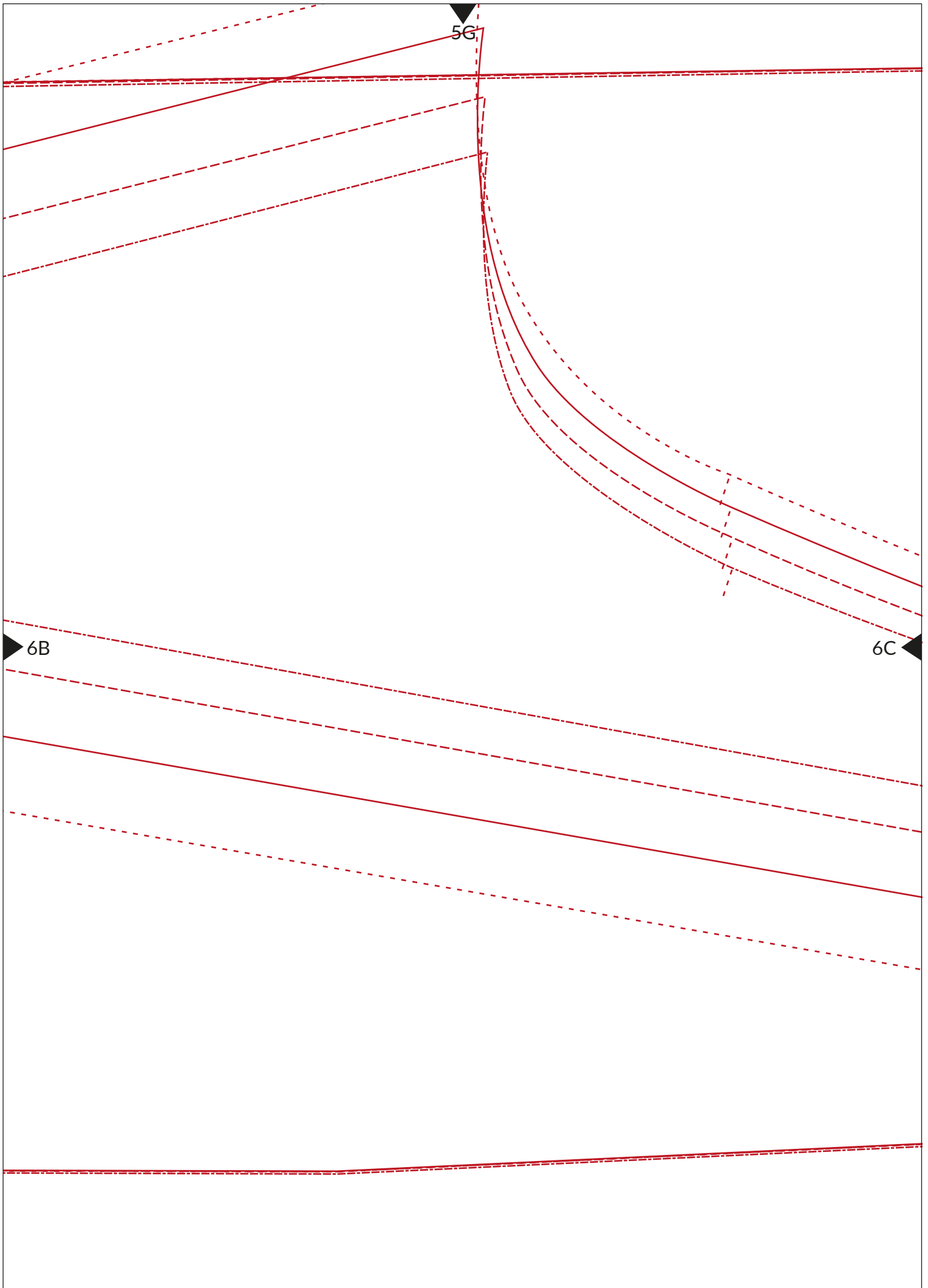

6D

11

Gopycat

TRENCH TOMASINA

INTERIOR MANGA DELANTERA

Talles:

----- 2XL/3XL

_____ L/XL

----- S/M

----- XS/2XS



CORTAR:

1 EN TELA DOBLE INTERIOR

No incluye márgenes de costura

5H



6C

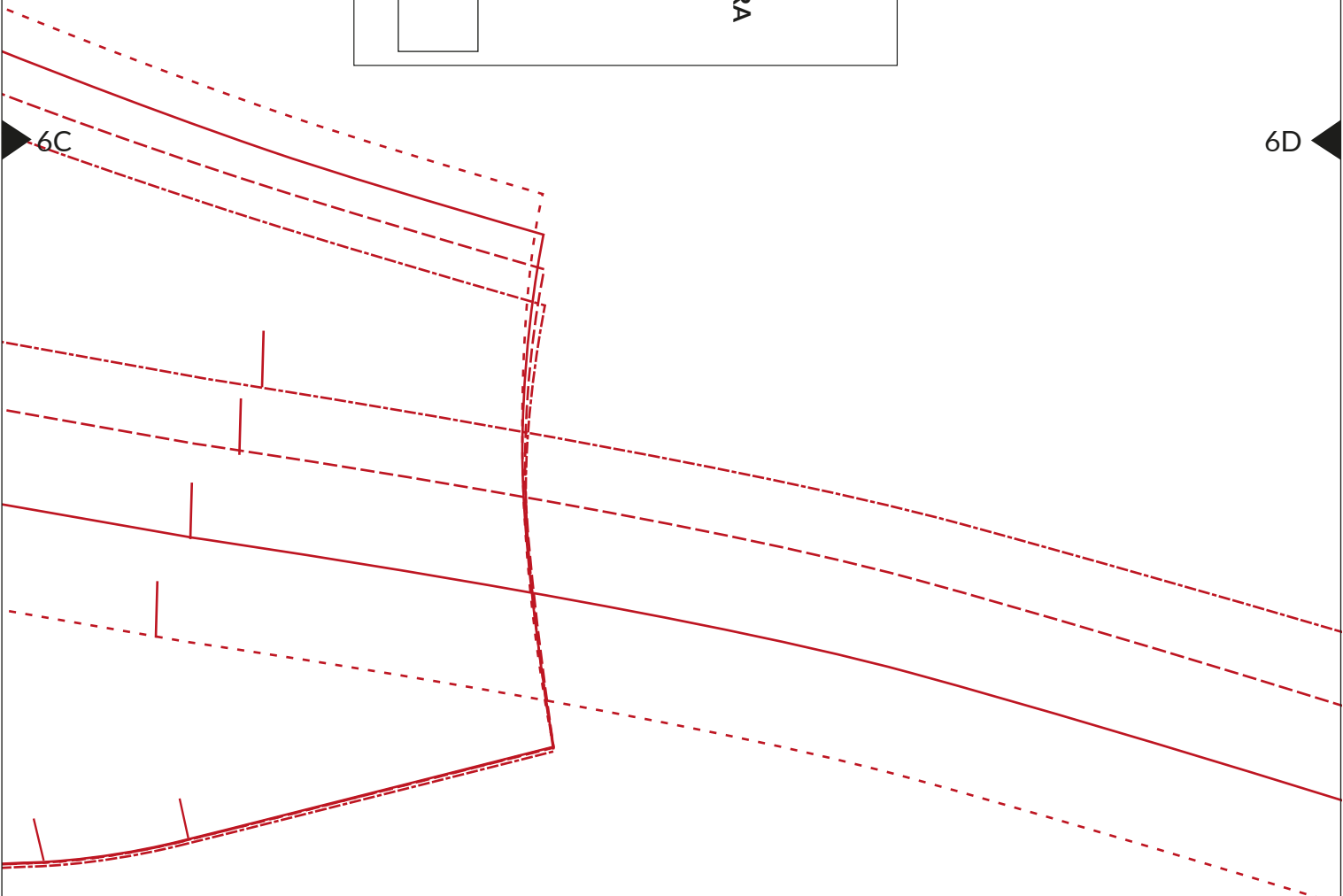

5i

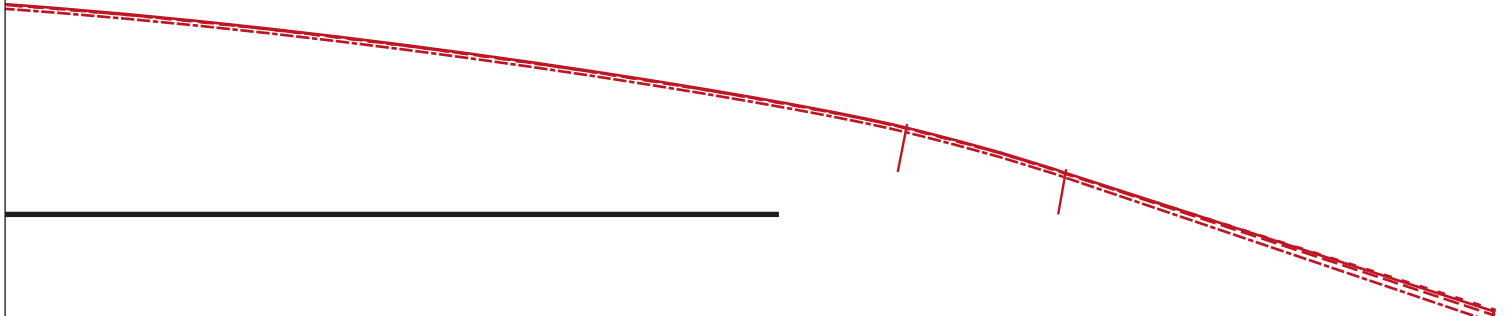

6D

